

SOLUCIONES (cortes seccionales)

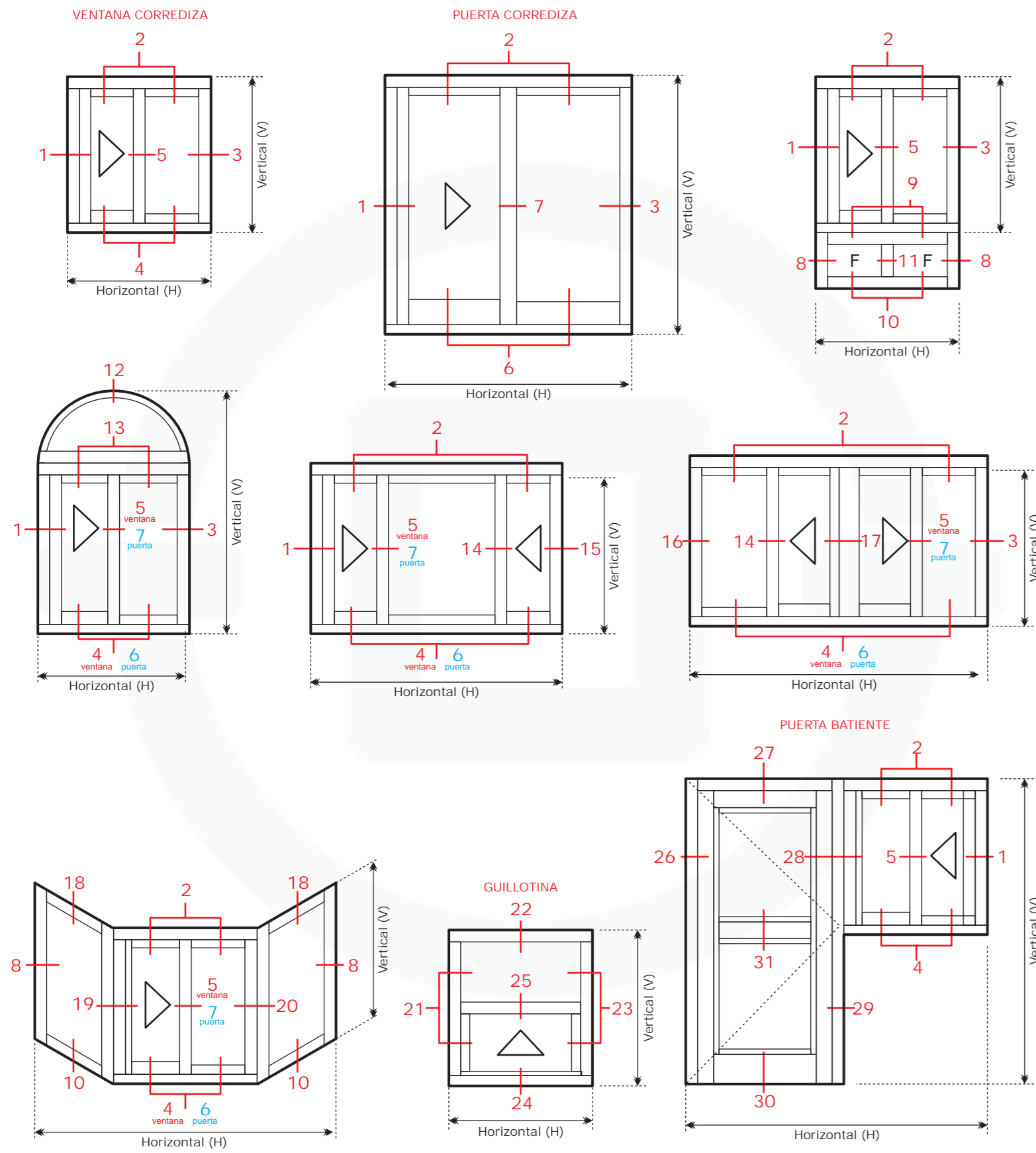

VENTANA CORREDIZA

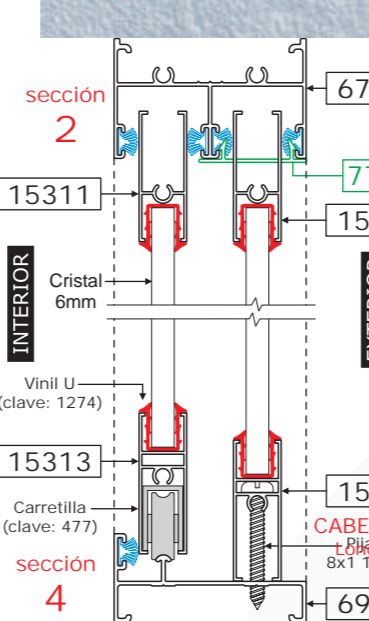

VENTANA CORREDIZA

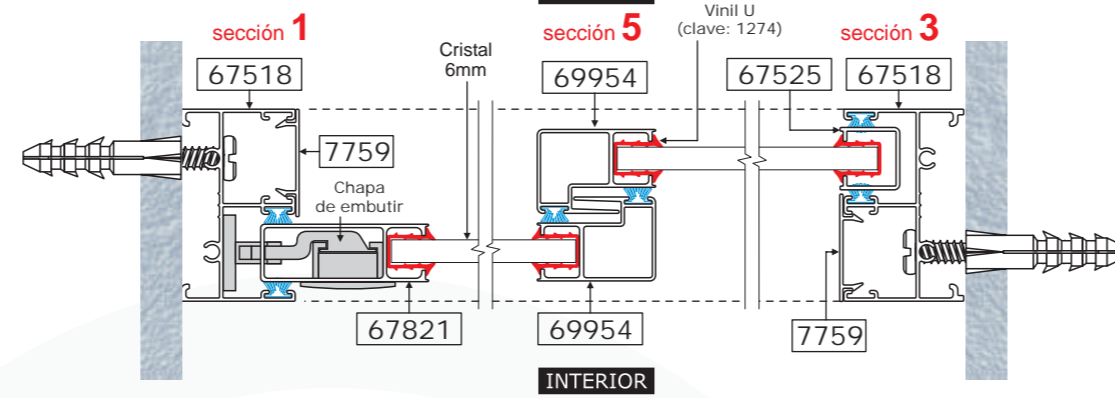

PUERTA CORREDIZA

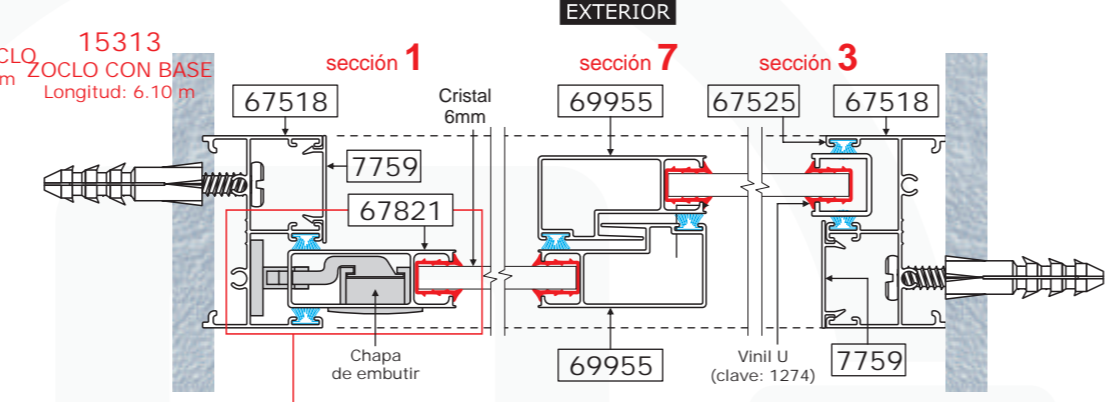

PUERTA CORREDIZA

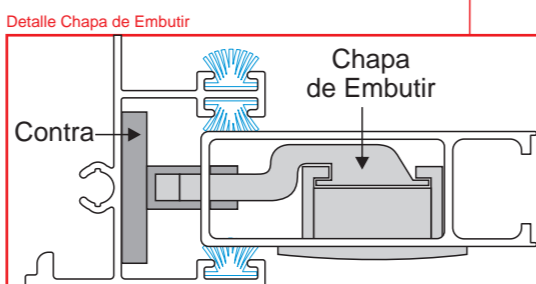
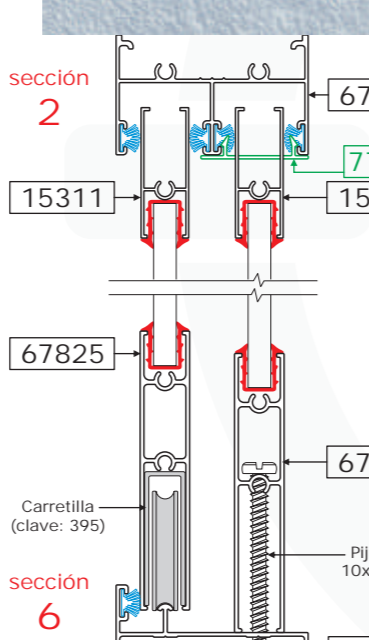

PUERTA CORREDIZA

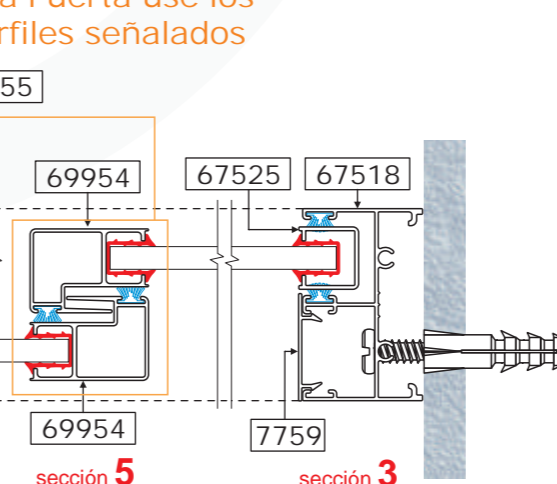
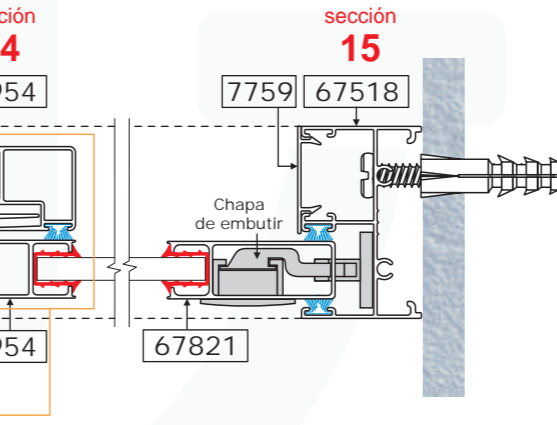
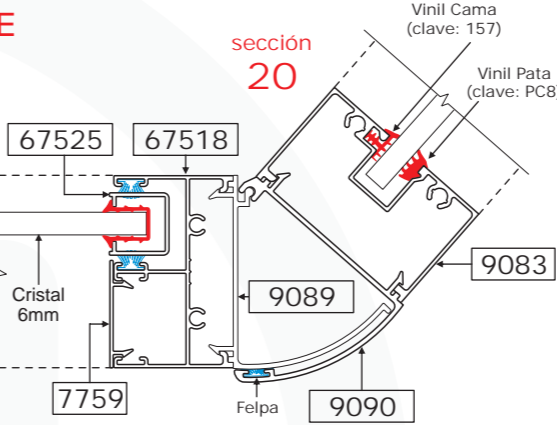
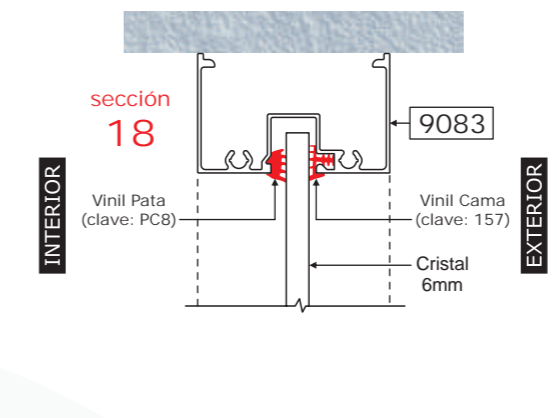
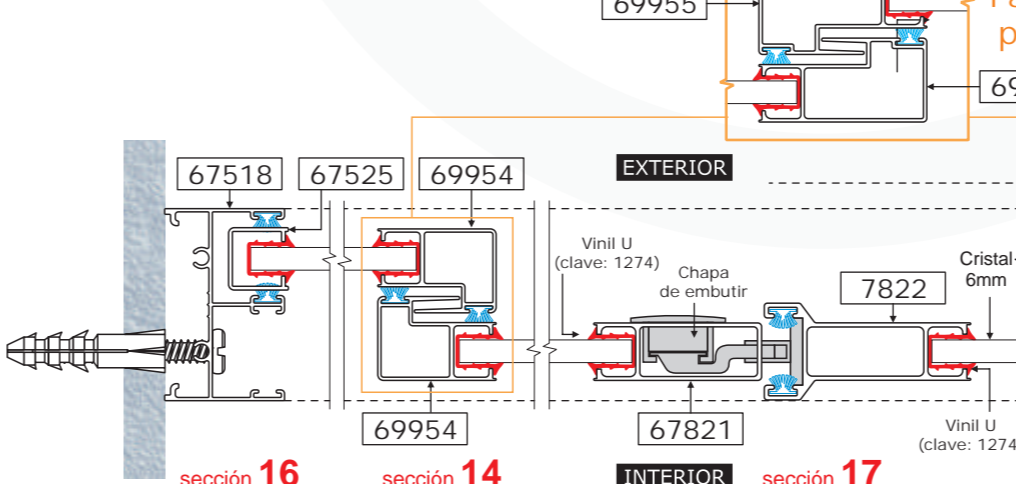
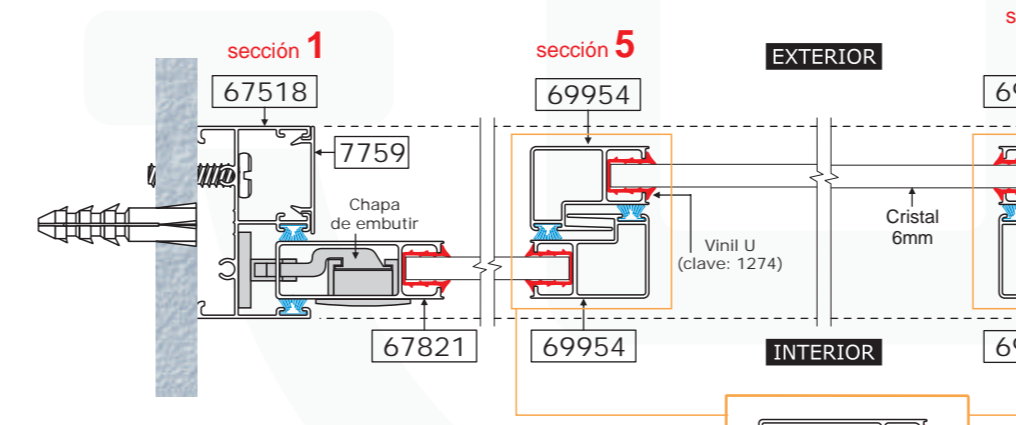
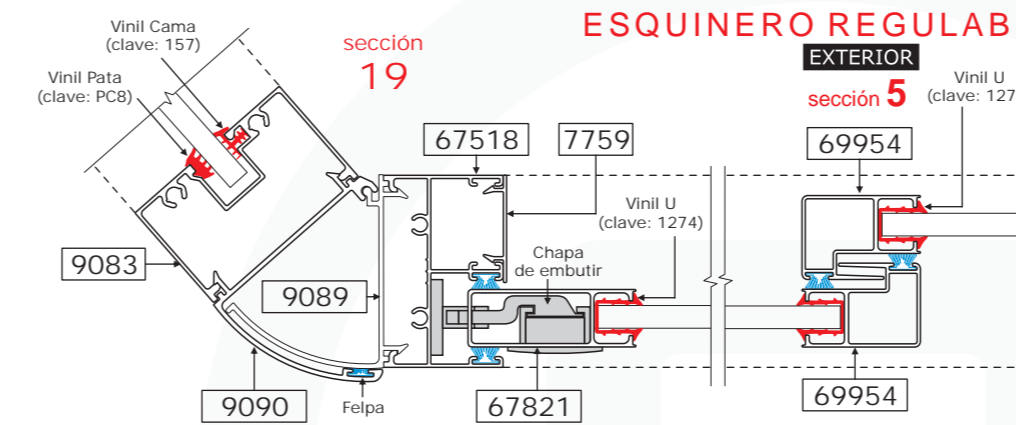
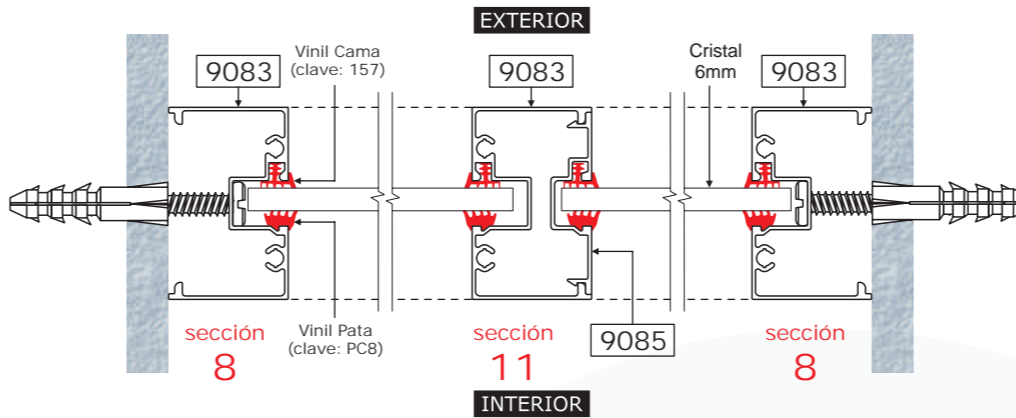
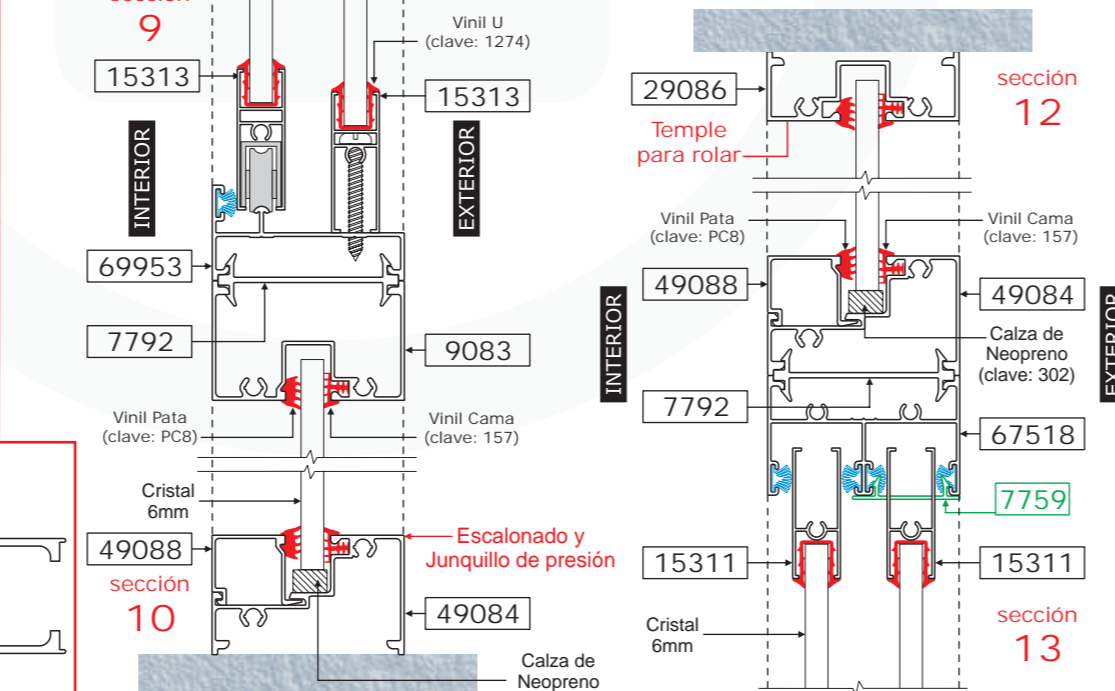

VENTANA GUILLOTINA

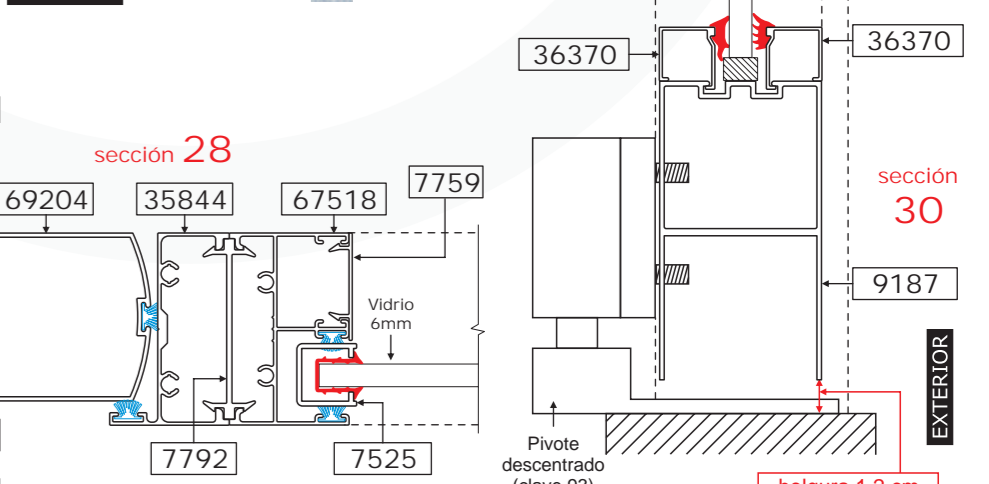
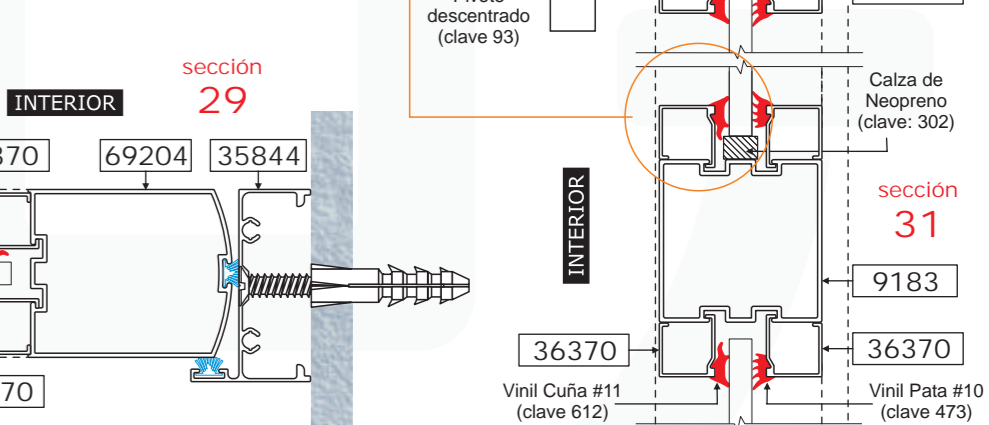
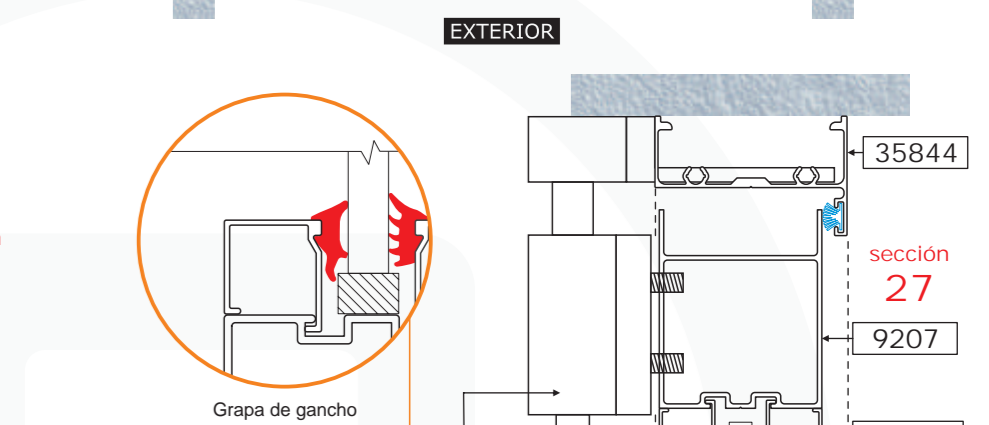
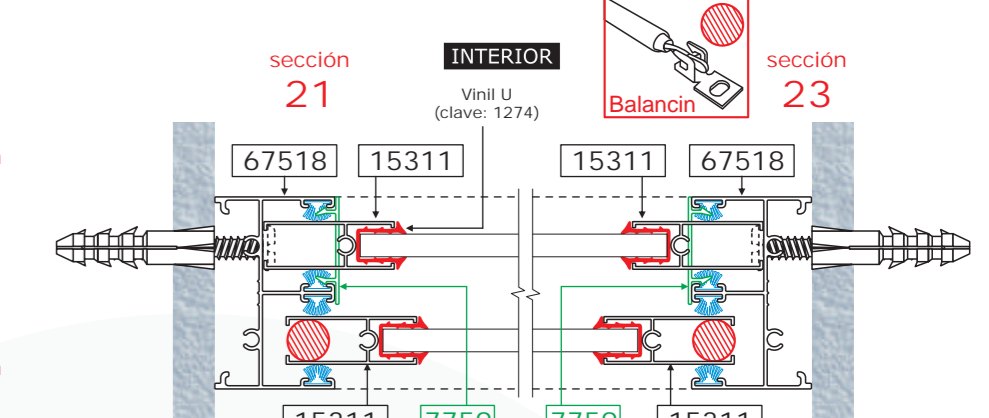
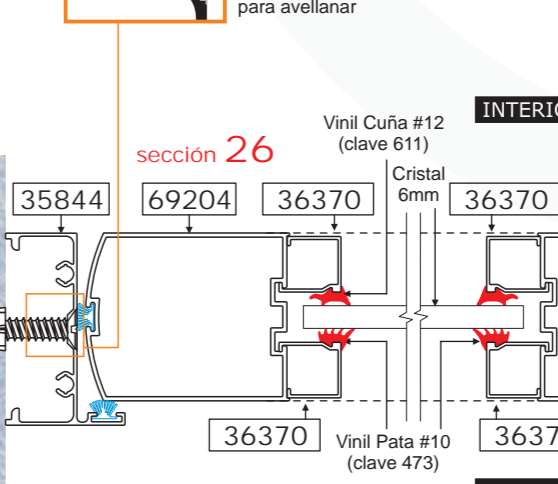
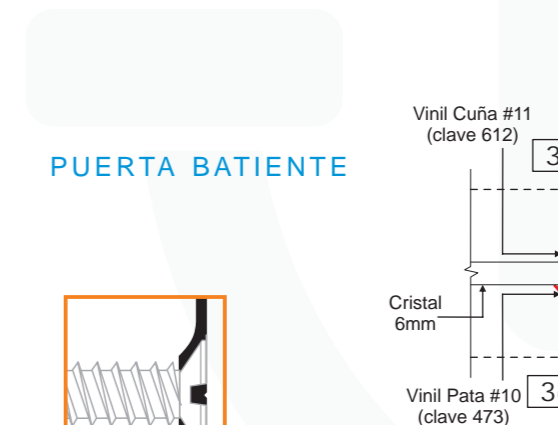
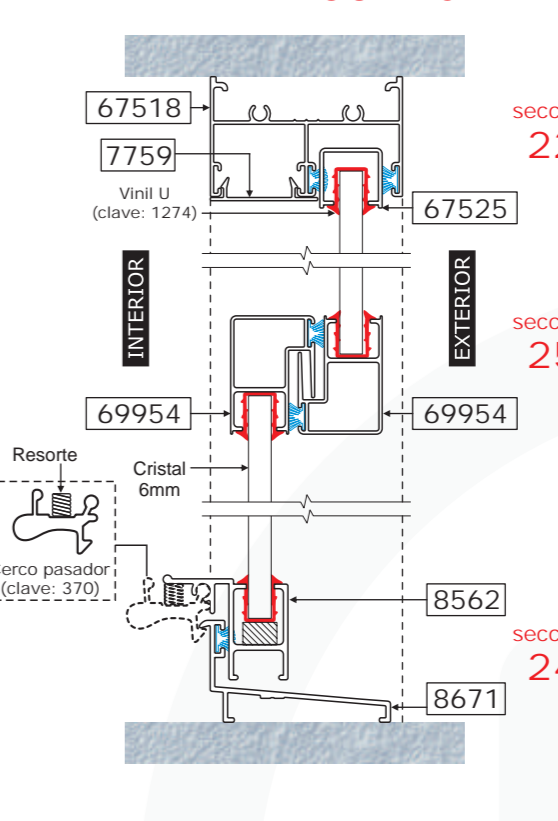

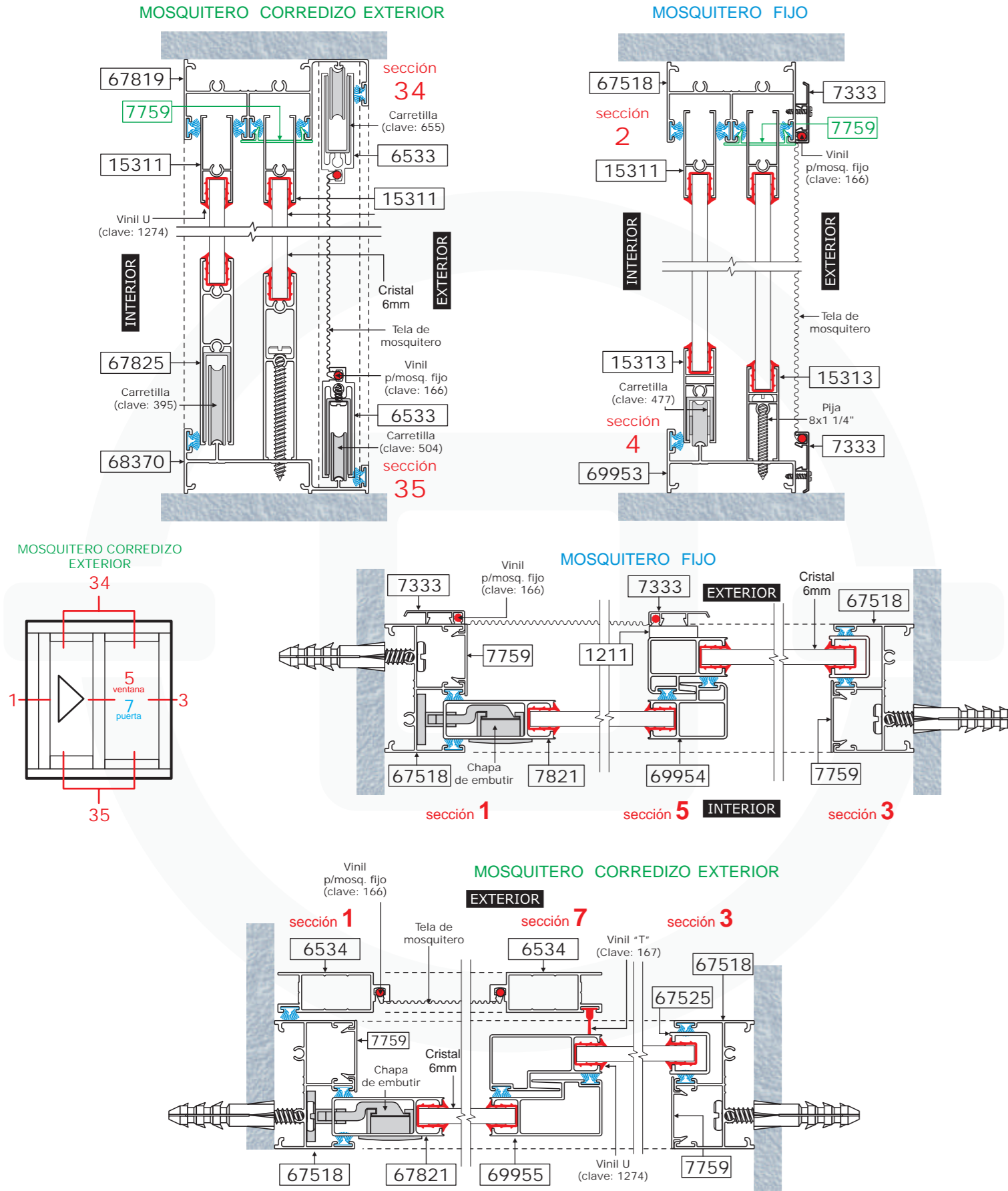

ANODIZADOS

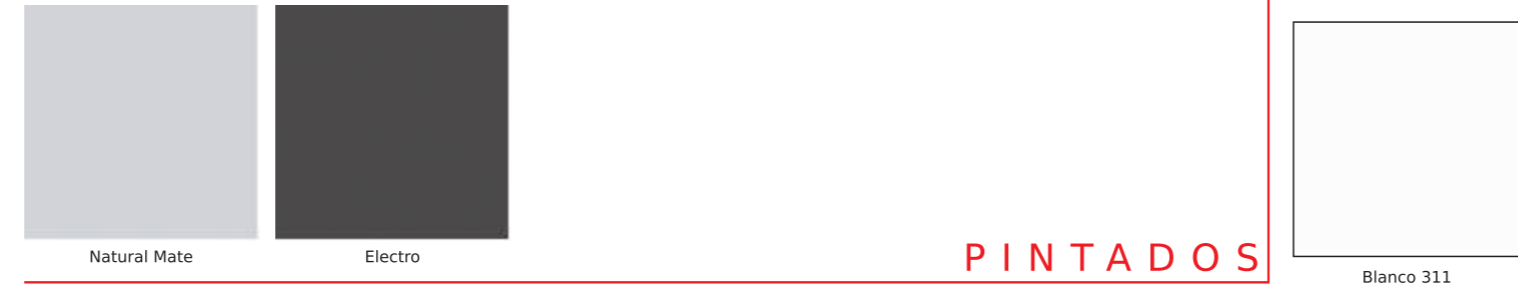

PINTADOS

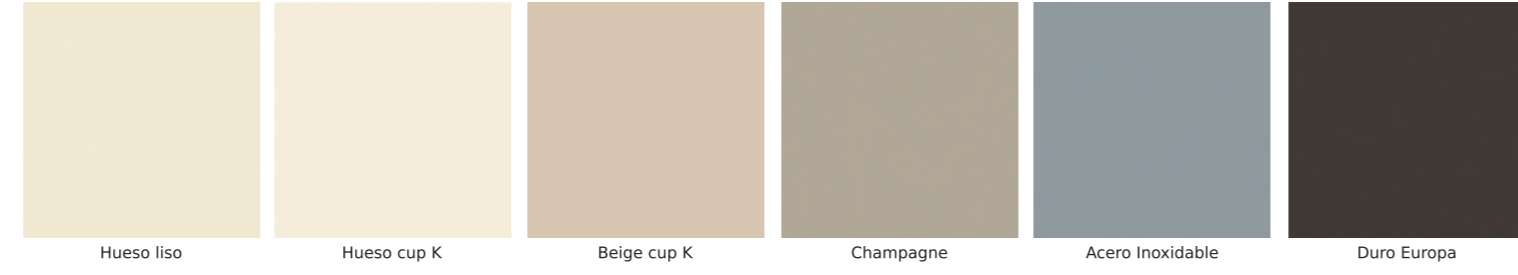

SUBLIMADOS



Nota: los colores mostrados pueden variar ligeramente del color original



HERRAJES



Kit para Ventana de 2"

- (18) Pijas 8x1 1/2" CF Clave: 104 (Armado de marco y hojas)
- (2) Pijas 8x1 1/4" CF Clave 467 (fijación del zócalo)
- (2) Pijas 8x1/2" CP Clave: 2820 (fijación de contra)
- (6) Tornillos para madera 10x 2" Clave:154 (fijación al muro)
- (6) Taquetes Anker 1/4" clave:135
- (2) Carretillas t/española sencilla Clave: 477
- (6) Tapones Clave:891
- (1) Jaladera de embutir p/2" Clave: 3000 (izquierda) ó 3001 (derecha)
- Vinil U clave:163
- Felpa 7mm x 5p clave:FG

Kit para Puerta de 2"

- (20) Pijas 8x1 1/2" CF Clave: 104 (Armado de marco y hojas)
- (2) Pijas 10 x 2" clave: 171 (fijación del zócalo)
- (4) pijas 8 x 1/2" Clave: 90 (para carretilla 395)
- (2) Pijas 8x1/2" CP Clave: 2820 (fijación de contra)
- (8) Tornillo para madera 10x 2" Clave:154 (fijación al muro)
- (8) Taquetes Anker 1/4" clave:135
- (2) Carretilla p/pta de 2" t/ española Clave: 395
- (9) Tapones Clave:891
- (1) Jaladera de embutir p/2" Clave: 3000 (izquierda) ó 3001 (derecha)
- Vinil U clave:163
- Felpa 7mm x 5p clave:FG

Kit p/Puerta Batiente 1 3/4" c/intermedio

- (4) Pijas 10 x 1" CF Clave: 107 (armado de marco)
- (8) Tornillos p/madera 10 x 3" clave: 155 (fijación al muro)
- (8) Taquetes Anker 1/4" clave:135
- (1) Pivote descentrado clave: 93
- (2) Tensores (clave según medida de la puerta)
- (28) Remaches #44 1/8" x 4/16" clave: 115
- (1) Chapa Doble manija clave: 2003 (Phillips mod. 549)
- (4) Calzas de Neopreno clave: 302
- Vinil Pata #10 clave: 473
- Vinil cuña # 11 clave: 612
- Felpa 7mm x 5p clave:FG

Kit para mosquitero corredizo

- (4) pijas 10x1 1/2" CF Clave:108
- (2) Carretillas t/española balero grande Clave:504
- (2) Carretillas sup. con fleje Clave: 655
- (1) Uñero p/mosq. Clave 26E
- Vinil cola de rata clave: 166 (por metro)
- Tela de mosquitero (por metro)
- Felpa FG 7mm x 5p
- Vinil T p/mosq.corr. Clave: 167

Kit para mosquitero fijo

- (4) pijas 8x1/2" CF Clave:90
- (4) Escuadra p/mosq. Clave:39
- Vinil cola de rata clave: 166 (por metro)
- Tela de mosquitero (por metro)